

JALADERAS PARA EMBUTIR



Guía de corte para mueble WFH111X75

Formato sin escala

Corte de mueble

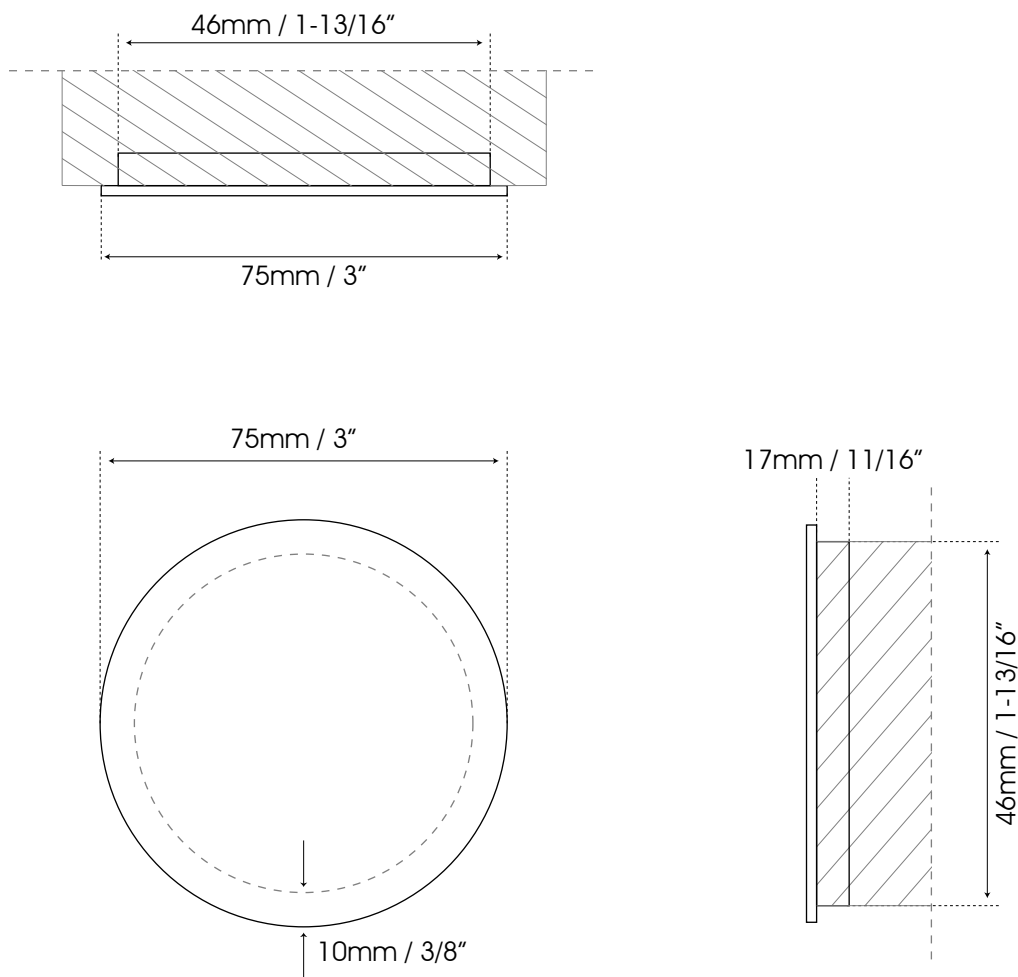

Aplicar pegamento
epóxico al borde.